

ADEPTUS®

ASSEMBLY INSTRUCTIONS

6+2 Drawer Roll Cart

#76171 - Matte Black Finish

#76183 - White Finish

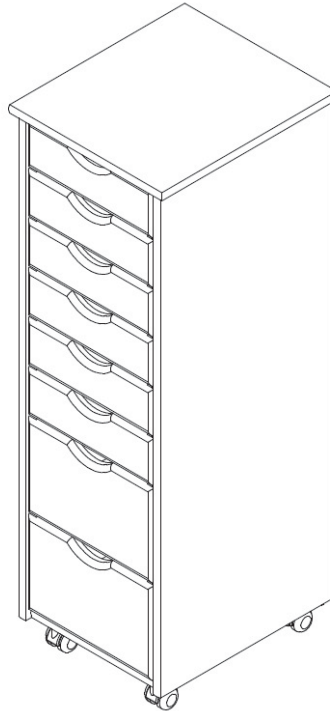

CUSTOMER SERVICE AND REPLACEMENT PARTS:

FOR FASTER SERVICE ON PARTS, PLEASE GO TO OUR WEBSITE AT WWW.ADEPTUS.COM; OR CALL TOLL FREE 1.888.ADEPTUS (1.888.233.7887) FOR ASSEMBLY QUESTIONS.
MON-FRI 10 A.M. TO 4 P.M. E.S.T., CLOSED HOLIDAYS

IF YOU CALL, PLEASE HAVE ON HAND:

- PRODUCT NAME AND STOCK NUMBER
- WHEN AND WHERE THE UNIT WAS PURCHASED
- P.O. NUMBER FROM THE BOTTOM OF THIS PAGE

IF WE ARE BUSY HELPING OTHER CUSTOMERS, PLEASE LEAVE YOU NAME AND NUMBER TO RECEIVE A RETURN CALL.
YOUR RETAILER MAY ALSO PROVIDE SERVICE OR PARTS.

HELPFUL OVERALL:

- SAVE THESE INSTRUCTION SHEETS AND THE BOX UNTIL YOU ARE SATISFIED WITH THE ASSEMBLY.
- DO NOT GLUE THE PARTS OF THE UNIT TOGETHER UNLESS YOU HAVE TESTED THE ASSEMBLY FIRST.
- PERFORM THE ASSEMBLY ON A CLEAN HARD SURFACE USING THE FLATTENED CARTON OR A TOWEL TO PROTECT THE SURFACE AND THE FINISH OF THE UNIT. DO NOT ASSEMBLE ON CARPET.

VISIT WWW.ADEPTUS.COM TO REGISTER YOUR PRODUCT AND SEE THE COMPLETE ADEPTUS LINE. REGISTRATION IS REQUIRED FOR PARTS REQUESTS.

THANK YOU FOR YOUR PURCHASE AND WELCOM TO ADEPTUS!

NOTICE: THE WRITTEN INSTRUCTIONS CONTAINED HEREIN ARE COPYRIGHTED. © copyright all rights reserved

Many People, One Thought

PROVIDING QUALITY SOLID WOOD FURNITURE AT AN AFFORDABLE PRICE HAS BEEN A GROUP EFFORT. FROM CONCEPT TO PRODUCT DESIGN, MANUFACTURING AND RETAILING, EACH AREA FOCUSES ON THE DETAILS THAT WILL ASSURE YOU A LOW PRICE. BUT NEVER AT THE EXPENSE OF FUNCTION, STYLING, OR GOOD SENSE.

A "READY - TO - ASSEMBLE" ITEM REDUCES TRANSPORTATION AND WAREHOUSING COSTS WHICH HELP YOUR RETAILER KEEP THEIR PRICES REASONABLE. NOW, YOU ARE JOINING "TEAM ADEPTUS" WITH THE FINAL STEP, ASSEMBLY.

• YOU ASSEMBLE, YOU SAVE •

WELCOME TO ADEPTUS!

This is a **SOLID WOOD** product:

We inspect all wood, and follow guidelines to pass quality inspections. Solid wood furniture has knots, small cracks, and what may look like blemishes. These characteristics are a natural by product of producing furniture from natural material.

We take extra care with our drawer parts:

1. We use real wood drawers sides.
2. The drawer sides are not painted to help protect your clothes from chemical odors and residue.
3. Finely sanded drawer parts eliminate snags when storing your clothes.

IMPORTANT

Perform the entire assembly on a clean, hard surface using the flattened box or a towel to protect the surface and the unit's finish. **DO NOT** assemble on carpet.

Carpet creates too much bounce making assembly difficult and could lead to damage of the parts.

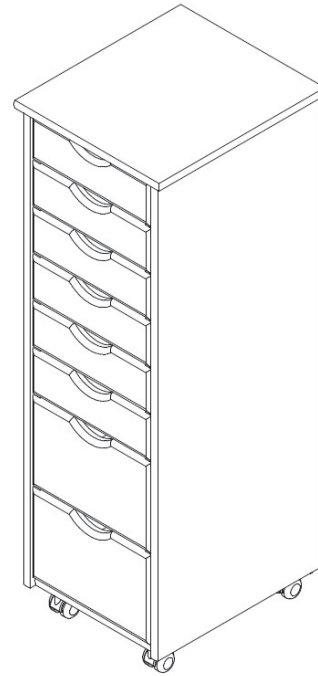

PLEASE NOTE:



DOWELS (PART A) VARY EVER SO SLIGHTLY. IF A DOWEL (PART A) IS LOOSE, WE PREFER YOU CALL OUR TOLL FREE NUMBER FOR ADDITIONAL DOWELS - VS GLUING THE DOWEL.



IF YOU CHOOSE TO GLUE THE PARTS, COMPLETELY TEST THE ASSEMBLY FIRST. WE DO NOT SUPPLY GLUE.

Safety and Care Advice

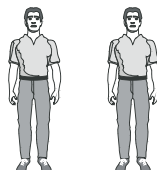
- Check you have all the components and tools listed on pages 3 & 4.
- Remove all fittings from the plastic bags and separate them into their groups.
- Keep children and animals away from the work area, small parts could choke if swallowed.
- Make sure you have enough space to layout the parts before starting.
- Do not stand or put weight on the product, this could cause damage.
- Assemble the item as close to its final position (in the same room) as possible.
- Opened box can be used to protect your floor or counter during assembly.
- Assembly is easier for drawer parts on a counter.
- Parts of the assembly will be easier with 2 people.
- We do not recommend the use of power drill/drivers for inserting screws, as this could damage the unit.
- Only use hand screwdrivers.
- Dispose of all packaging carefully and responsibly.

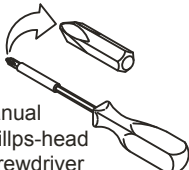
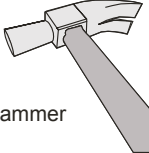
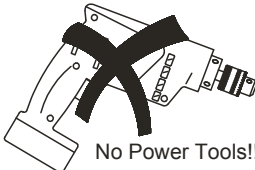
These tools are not supplied by the manufacturer.

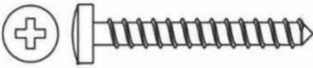
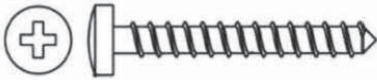
		 35 min	 Manual Phillips-head Screwdriver	 Hammer	 No Power Tools!!
---	---	---	---	--	--

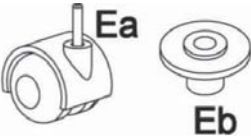
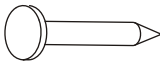
A		Dowel 8.0 x 30mm	12
B		Screw 3.0 x 25mm	64
C		Screw 4.0 x 30mm	12
D		Drawer Runner	16
E		(Ea) Caster and (Eb) Caster Insert Pair	04
F		Nail 1.5 x 19mm	32

These tools are not supplied by the manufacturer

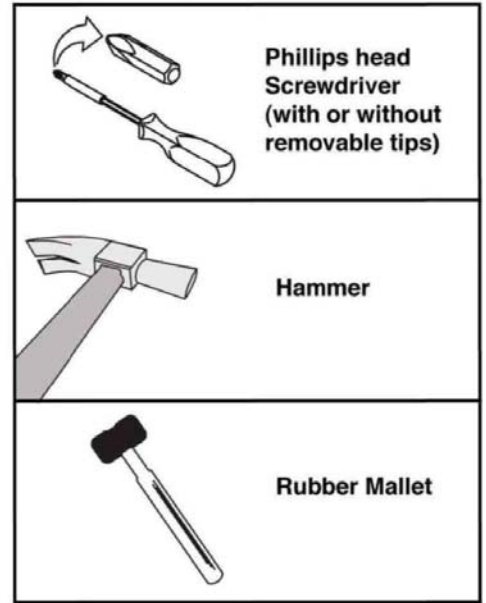

TIP: DOWELS (PART A) VARY EVER SO SLIGHTLY.
IF A DOWEL (PART A) IS LOOSE
WE PREFER YOU CALL OUR TOLL FREE
NUMBER FOR ADDITIONAL DOWELS -
VS GLUING THE DOWEL.

COMPLETELY TEST ASSEMBLY FIRST
IF YOU CHOOSE THE GLUE PARTS.
WE DO NOT SUPPLY GLUE.

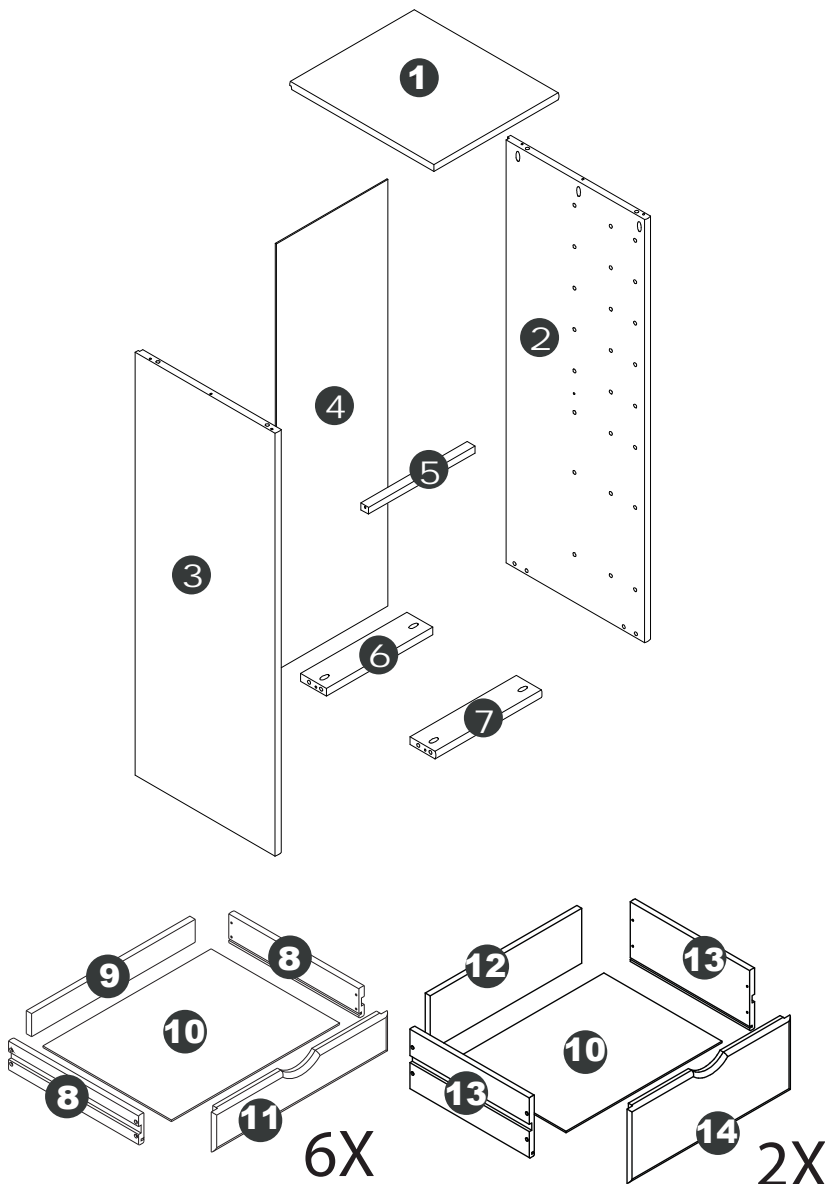

1	TOP
2	RIGHT SIDE
3	LEFT SIDE
4	BACK PANEL
5	MIDDLE CROSSBAR
6	BACK CASTOR SUPPORT
7	FRONT CASTOR SUPPORT
8	SMALL DRAWER SIDE
9	SMALL DRAWER BACK
10	DRAWER BOTTOM
11	SMALL DRAWER FRONT
12	LARGE DRAWER BACK
13	LARGE DRAWER SIDE
14	LARGE DRAWER FRONT

1

PREPARE PARTS FOR ASSEMBLY



IMPORTANT

Please do your entire assembly on a clean, clear surface to avoid damage. The flattened carton or a towel, placed ON a hard floor, not carpet, will work best for large parts. Drawers are best assembled on a counter.

Assembly on a carpet creates too much bounce.

- PUSH THE DOWELS (PART A) INTO THE EDGES OF THE FOLLOWING PARTS, AS SHOWN:
(PART 2) RIGHT SIDE
(PART 3) LEFT SIDE
(PART 6) BACK CASTOR SUPPORT
(PART 7) FRONT CASTOR SUPPORT

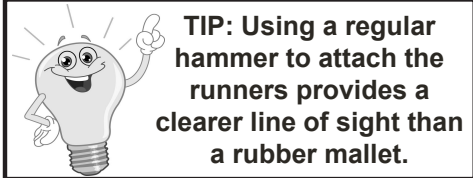
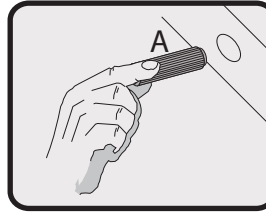

ATTACHING DRAWER RUNNERS:

- LINE UP PIPS IN DRAWER RUNNER (PART D) TO THE RIGHT SIDE PANEL (PART 2).
- **SEE DIAGRAM AND READ BELOW TIP FIRST, PLEASE!**
TIP: TAP IN ONE END OF THE RUNNER (PART D), THEN THE OTHER END. LEAVE THE MIDDLE FOR LAST.
- REPEAT TO ATTACH DRAWER RUNNERS (PART D) WITH THE LEFT SIDE (PART 3)

NEXT PREPARE CASTER SUPPORTS:

- USE A HAMMER OR RUBBER Mallet TO INSERT CASTER INSERT (PART Eb) INTO THE BOTTOM OF THE FRONT CASTER SUPPORT (PART 7) AND BACK CASTER SUPPORT (PART 6)
- TAP ABOVE THE BACK OF THE CASTER (ABOVE THE STEM) TO ASSEMBLE CASTERS (PART Ea) INTO THE CASTER INSERT (PART Eb).

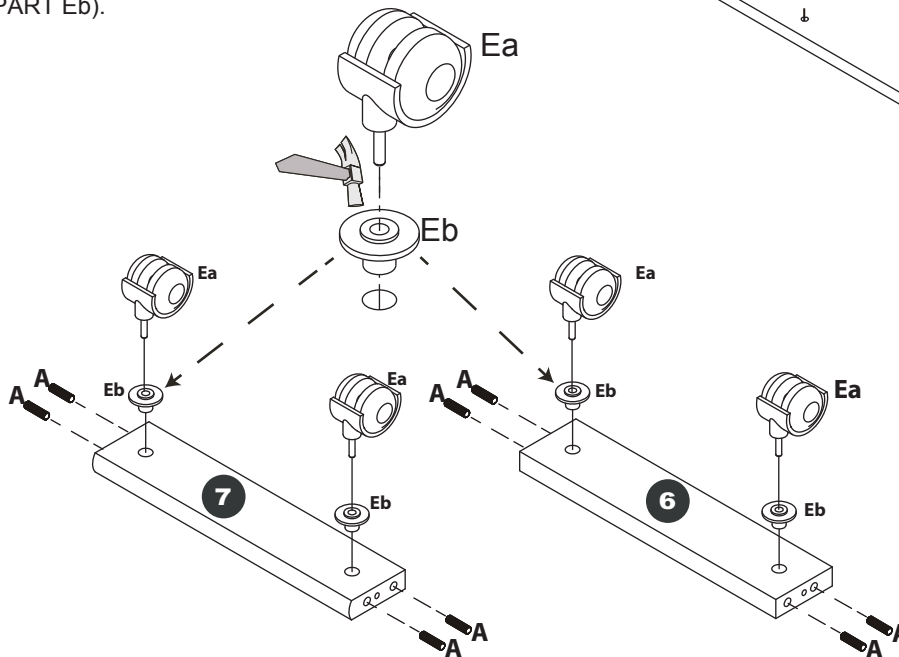

A=12 Dowel 8,0 x 30mm	D=16 Drawer Runner	Ea=04 Eb=04 Caster & Insert
-------------------------------------	----------------------------------	--

2

ATTACH THE SIDES TO THE CROSSBARS

TIP: DO ONE SIDE AND THEN THE OTHER SIDE

- DO NOT STAND LEFT SIDE (PART 3) UP ON THE EDGE YET. TO EASE ASSEMBLY, LAY SIDE FLAT ON THE FLOOR, RUNNER SIDE VISIBLE.
- MATCH UP BACK CASTER SUPPORT PART 6) AND FRONT CASTER SUPPORT (PART 7) AT DOWEL HOLES LOCATED AT THE BOTTOM OF SIDE.
- PLEASE CHECK THAT THE DISTANCES MATCH TO THE SQUARE DIAGRAM.
- SECURE BACK CASTER SUPPORT (PART 6) TO THE LEFT SIDE (PART 3) USING SCREW (PART C). SEE THE ROUND DIAGRAM, A BLOW UP IMAGE OF THE SCREW POSITIONING THROUGH THE ANGLED POCKET HOLES.
- SECURE FRONT CASTER SUPPORT (PART 7) WITH SCREWS (PART C) TO THE LEFT SIDE (PART 3) IN THE SAME MANNER.
- CAREFULLY TURN LEFT SIDE (PART 3) TO ITS BACK EDGE, AS SHOWN IN THE DIAGRAM.
- POSITION RIGHT SIDE (PART 2) TO LINE UP THE CROSSBARS (PART 6 AND 7) AT THE DOWEL HOLES AT BASE OF THE RIGHT SIDE (PART 2).
- SECURE CASTER SUPPORTS (PART 6 AND 7) TO RIGHT SIDE (PART 2) USING SCREW (PART C) AND SHOWN IN THE DIAGRAM. TIP: HAND TIGHTEN FOR THE BEST FIT.
- ATTACH (PART 5) MIDDLE CROSSBAR TO BOTH SIDES OF THE UNIT AT THE SIDE DRILLED HOLE. DO NOT USE A DRILL. HAND TIGHTEN.

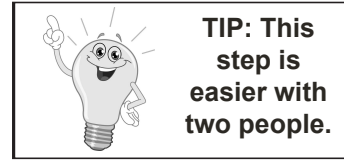
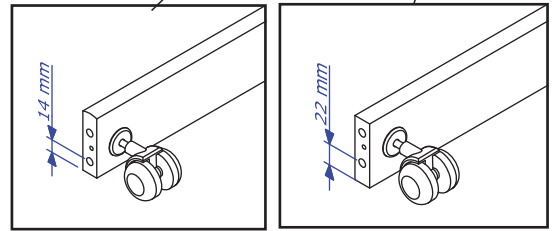
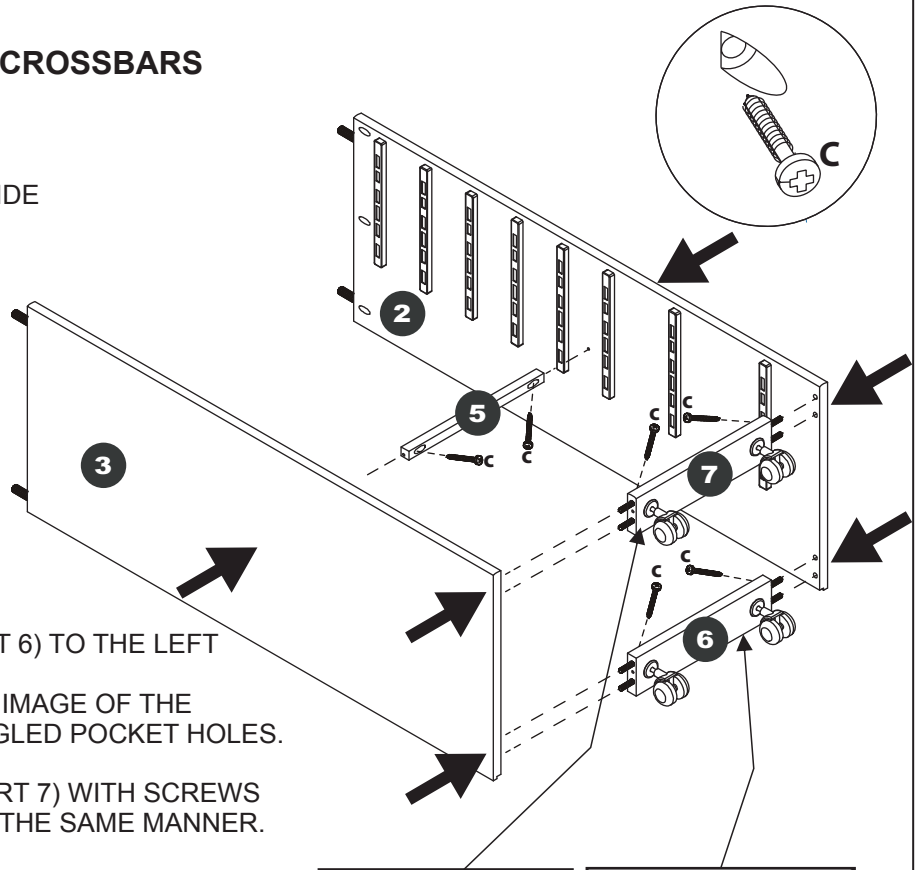

TIP: This step is easier with two people.

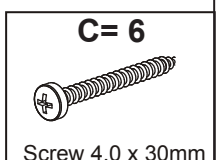

3

ATTACH THE TOP

- LINE UP DOWEL HOLES IN TOP (PART 1) WITH DOWELS IN UNIT'S SIDES.
- TIP: TRY TURNING THE UNIT UPSIDE DOWN TO GET A BETTER POSITION TO SEE AND SCREW TOP (PART 1) TO SIDES OF UNIT.
- SEE ROUND DIAGRAM: SLIDE (PART C) SCREWS THROUGH ANGLED POCKET HOLES AND HAND TIGHTEN FOR BEST FIT.

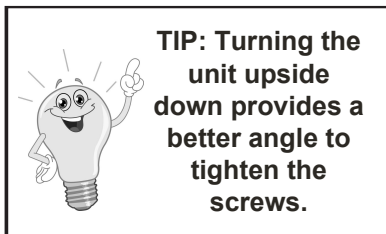
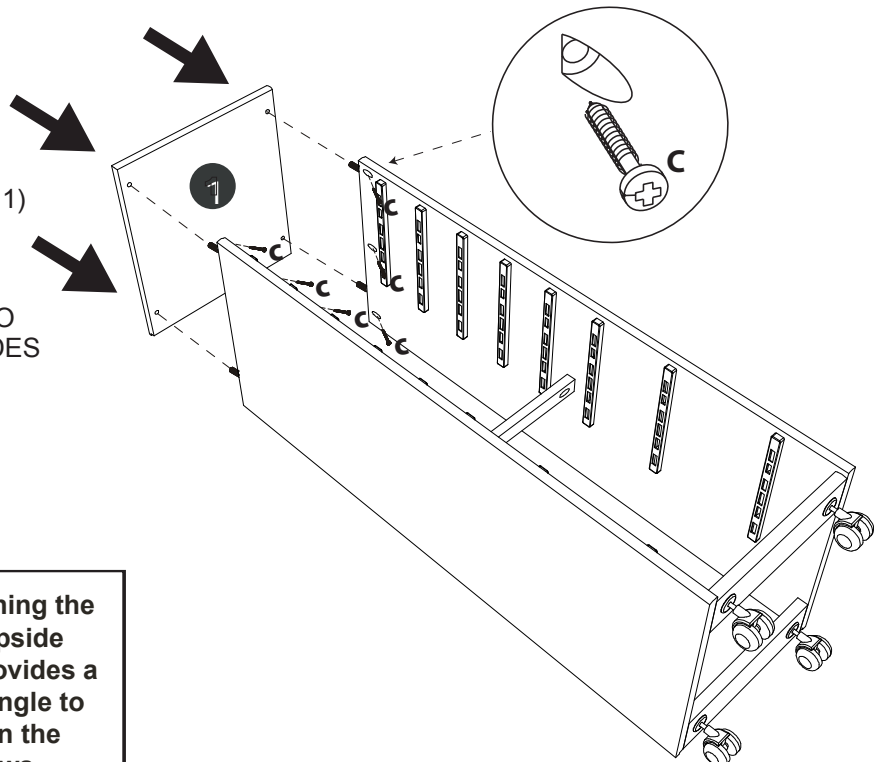

TIP: Turning the unit upside down provides a better angle to tighten the screws.

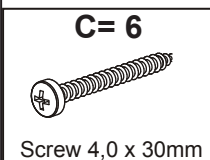

4

ATTACH THE BACK PANEL



Use all back panel nails, evenly spaced. They help make the unit strong.

- HOLD THE (PART 4) BACK PANEL IN THE GROOVES INSIDE THE UNIT'S SIDES.
- ALSO MAKE SURE THE BACK PANEL FITS IN THE GROOVE AT THE BACK OF THE TOP.
- CHECK THAT THE UNIT IS SQUARE.
- SECURE THE (PART 4) BACK PANEL USING THE (PART F) NAILS.

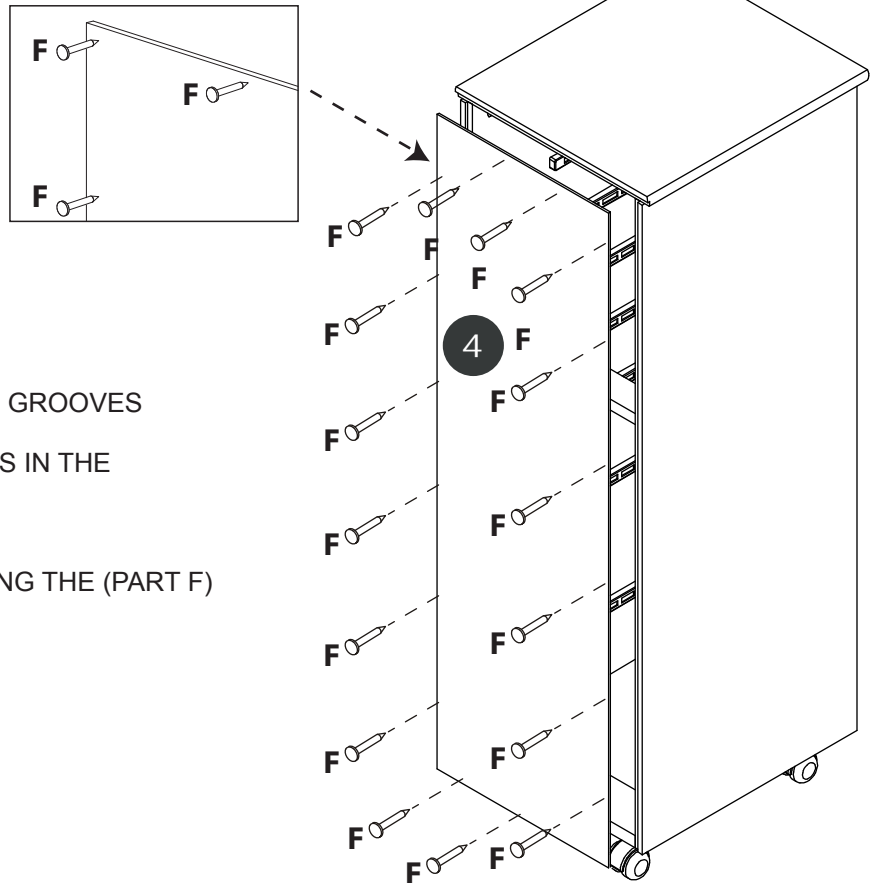
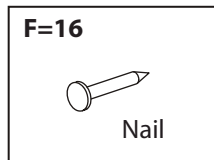

5

ASSEMBLE THE SMALL DRAWERS

- LINE UP THE BOTTOM EDGE OF THE DRAWER SIDE (PART 8) WITH THE BOTTOM EDGE OF THE DRAWER FRONT (PART 11).
- JOIN THE PARTS USING TWO SCREWS (PART B) AS SHOWN IN THE DIAGRAM.

TIP: THE SCREWS' SHARP TIPS ARE SELF TAPPING, SO THE DRAWER FRONT DOES NOT NEED A PILOT HOLE. THE SHARP TIP STARTS THE HOLE, AND THE SCREW THREADS WILL SECURE THE PART IN PLACE FOR A TIGHT FIT.

- REPEAT ON THE OTHER SIDE OF THE DRAWER.
- SLIDE IN DRAWER BOTTOM (PART 10) THROUGH GROOVES IN THE DRAWER SIDES (PART 8). THIS WILL START SQUARING UP THE DRAWER.
- LINE UP DRAWER BACK (PART 9) WITH BOTH DRAWER SIDES (PART 8). CHECK THAT IT IS SQUARE.
- SCREW THE DRAWER BACK (PART 9) TO THE DRAWER SIDES (PART 8)
- TURN THE DRAWER OVER. CONFIRM THE DRAWER BOTTOM (PART 10) COVERS THE DRAWER BACK (PART 9). NAIL THE DRAWER BOTTOM (PART 10) THROUGH TO THE DRAWER BACK (PART 9) USING (2) NAILS (PART F).

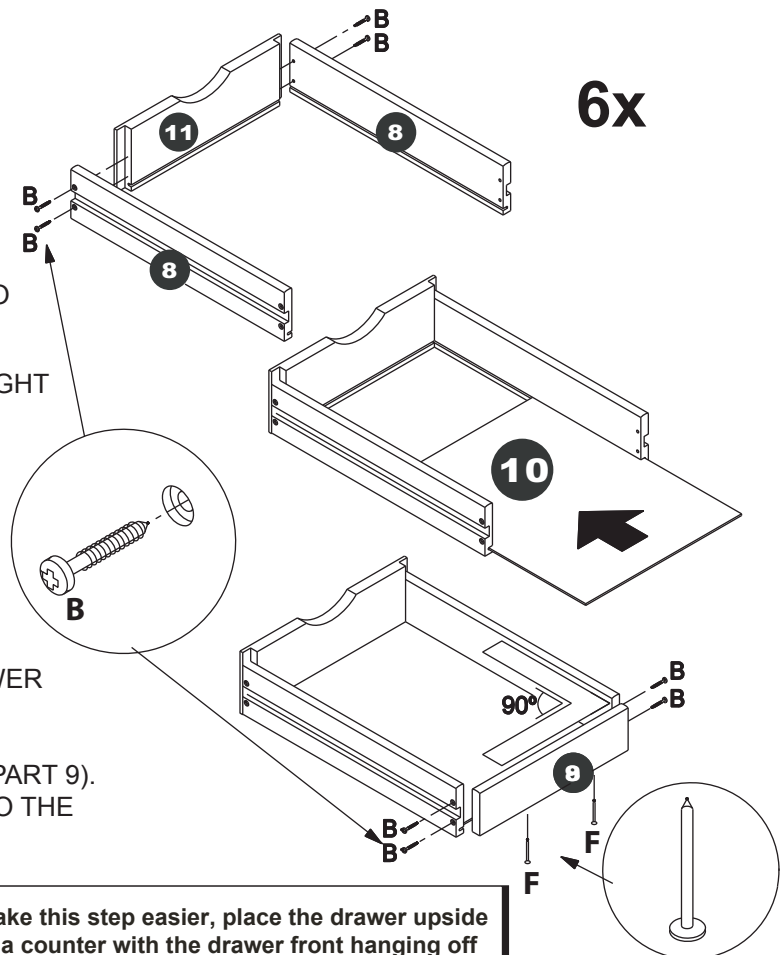

B=48



F=12



TIP: To make this step easier, place the drawer upside down on a counter with the drawer front hanging off the edge. This will allow the drawer box to lay flat and provide better control for hammering the nails.

6

ASSEMBLE THE LARGE DRAWERS

- LINE UP THE BOTTOM EDGE OF THE BIG DRAWER SIDE (PART 13) WITH THE BOTTOM EDGE OF THE DRAWER FRONT (PART 12).
- JOIN THE PARTS USING TWO SCREWS (PART B) AS SHOWN IN THE DIAGRAM.

TIP: THE SCREWS' SHARP TIPS ARE SELF TAPPING, SO THE DRAWER FRONT DOES NOT NEED A PILOT HOLE. THE SHARP TIP STARTS THE HOLE, AND THE SCREW THREADS WILL SECURE THE PART IN PLACE FOR A TIGHT FIT.

- REPEAT ON THE OTHER SIDE OF THE DRAWER.
- SLIDE IN DRAWER BOTTOM (PART 10) TROUGH GROOVES IN THE DRAWER SIDES (PART 13). THIS WILL START SQUARING UP THE DRAWER.
- LINE UP THE LARGE DRAWER BACK (PART 14) WITH BOTH LARGE DRAWER SIDES (PART 13). CHECK THAT IT IS SQUARE.
- SCREW THE LARGE DRAWER BACK (PART 14) TO THE LARGE DRAWER SIDES (PART 13)
- TURN THE DRAWER OVER. CONFIRM THE DRAWER BOTTOM (PART 10) COVERS THE DRAWER BACK (PART 14). NAIL THE DRAWER BOTTOM (PART 10) THROUGH TO THE DRAWER BACK (PART 14) USING (2) NAILS (PART F).

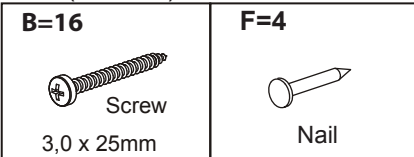
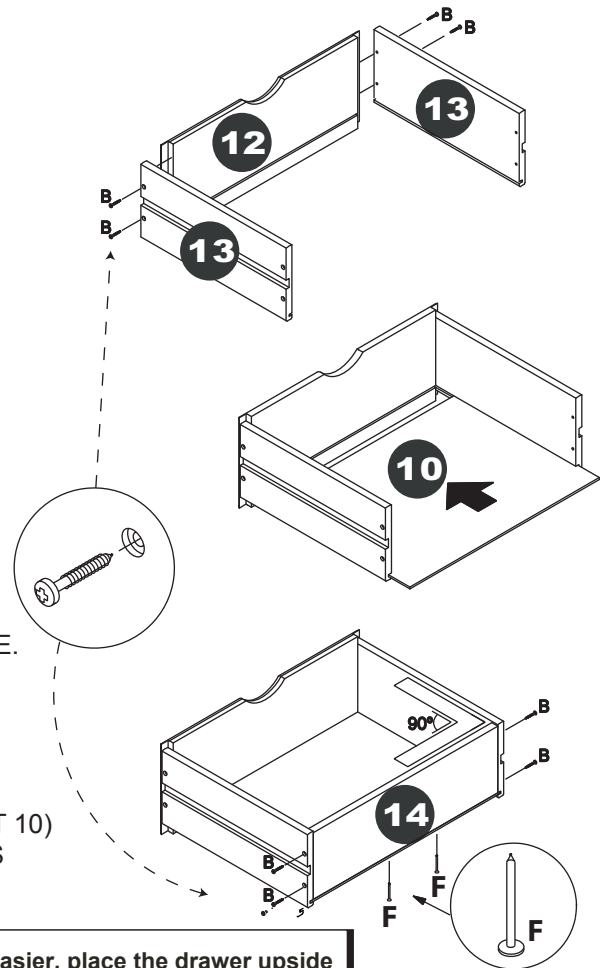

TIP: To make this step easier, place the drawer upside down on a counter with the drawer front hanging off the edge. This will allow the drawer box to lay flat and provide better control for hammering the nails.

7

INSERT DRAWERS AND COMPLETE ASSEMBLY

- THE DRAWER SIDES HAVE A CHANNEL THROUGH THE MIDDLE OF THE PART. THIS CHANNEL SLIDES OVER THE DRAWER RUNNERS (PART D).
- SLIDE ALL DRAWERS IN. CHECK THE DRAWERS RUN SMOOTH. ONE DRAWER FRONT SHOULD NOT OVERLAP ANOTHER DRAWER FRONT EDGE.

TIP: IF THAT HAPPENS, THE DRAWER FRONT IS NOT ASSEMBLED LEVEL. SIMPLY BACK OUT ONE SET OF THE SCREWS ON A DRAWER SIDE AND ADJUST UNTIL IT IS TO YOUR SATISFACTION. (REMEMBER TO LINE THE BOTTOM EDGES OF THE DRAWER SIDE AND DRAWER FRONT UP.)

- STEP BACK TO LOOK AT UNIT. YOU MAY PREFER TO MOVE ONE DRAWER TO ANOTHER'S POSITION.

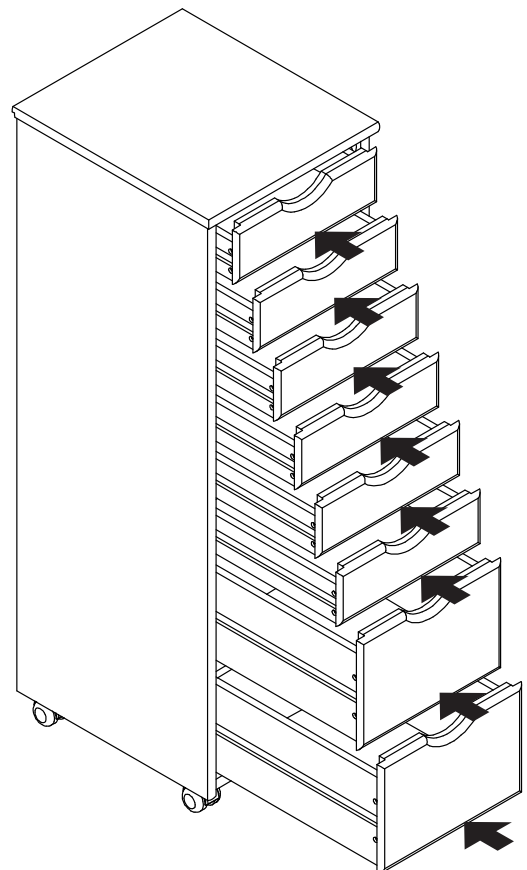

**COMPLETED ASSEMBLY:
THANK YOU FOR YOUR PURCHASE, AND WELCOME TO ADEPTUS!**

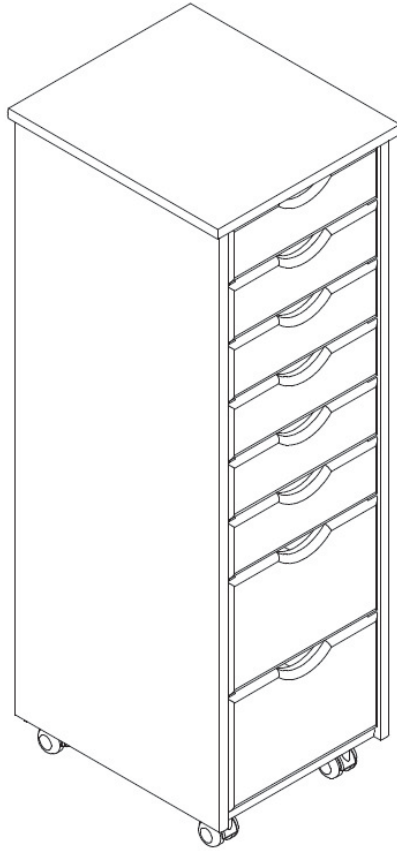

USE AND CARE INSTRUCTIONS:

CARE INSTRUCTIONS:

- NORMAL USE: WIPE WITH A CLEAN CLOTH.
- WHEN NEEDED TO CLEAN SCUFFS:WIPE CLEAN WITH A SLIGHTLY DAMP CLOTH AND A MILD CLEANER. THEN WIPE DRY WITH A CLEAN CLOTH.

USE:

MULTI-PURPOSE MOBILE STORAGE UNIT FOR HOME, OFFICE, CRAFT ROOM, KITCHEN, OR GARAGE.